



CATALOGUE

TIMS

CAGE
PERFORATED
LADDER

The Integrity of Successful &
Working Perfectly

PRODUCT

Cage

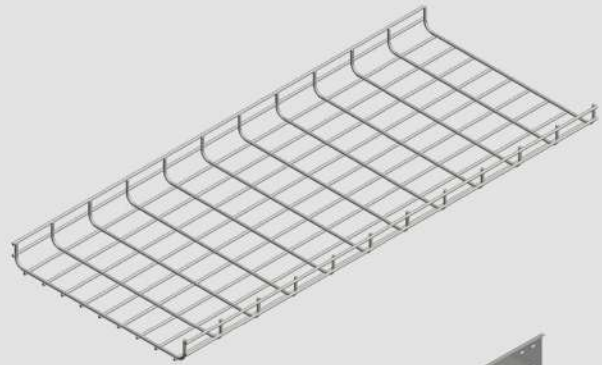

Cable Duct Type C

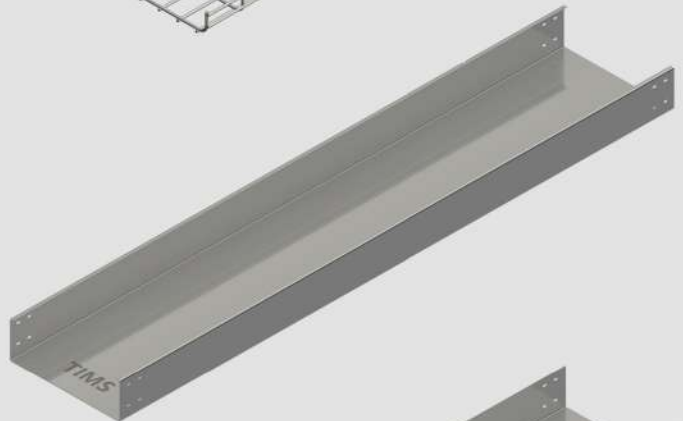

Cable Duct Type U

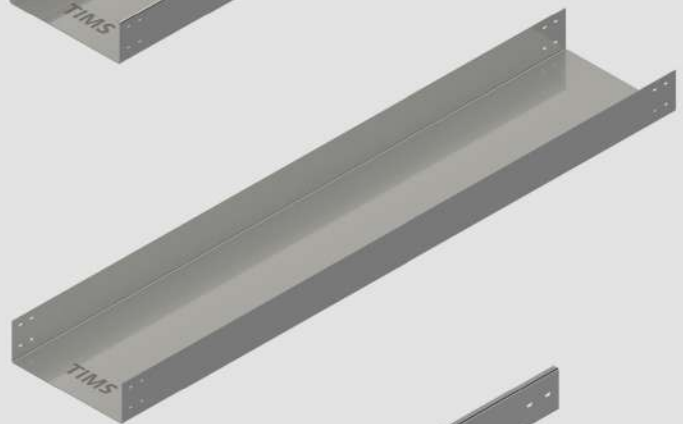

Ladder H



PRODUCT

Ladder U



Ladder W



Tray C



Tray U

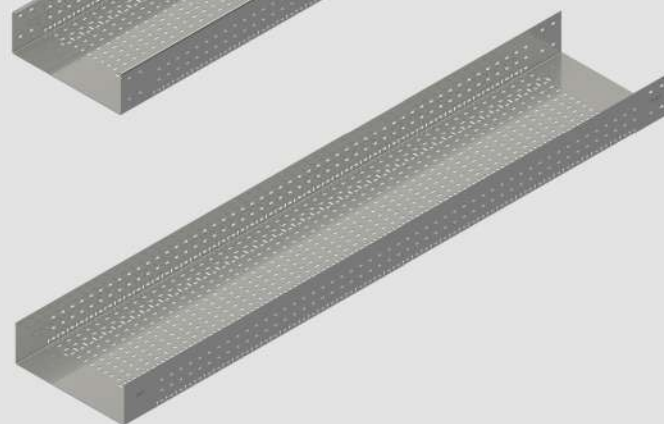

PRODUCT

Cage

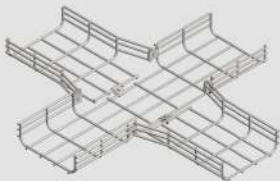
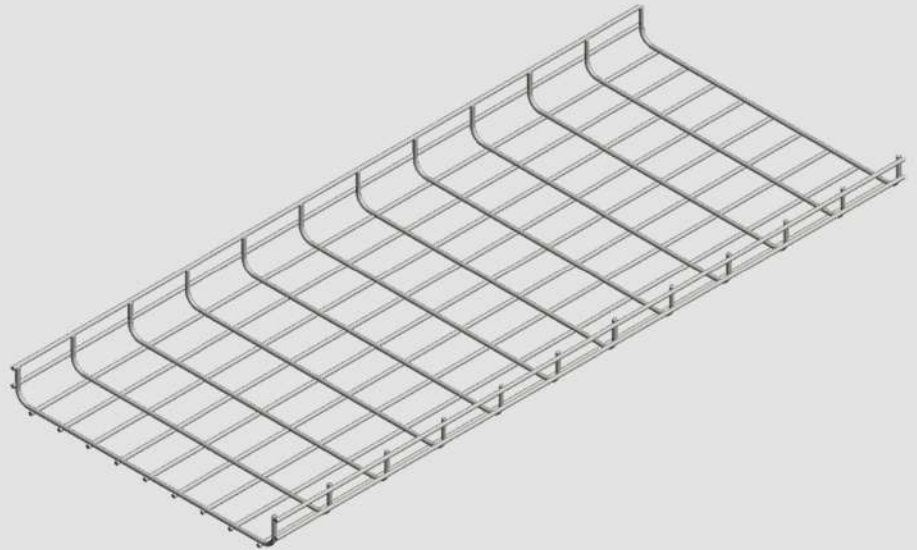

Cross Cage



Elbow Cage

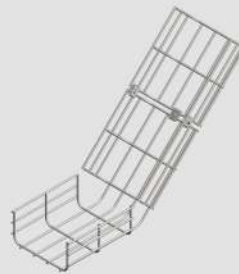

IR Cage

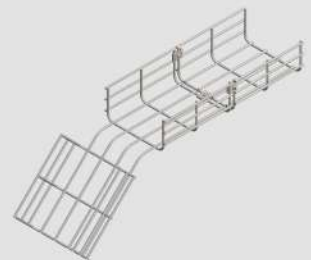

OR Cage



Reducer Cage

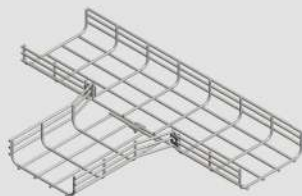

Tee Cage



Joiner U20



Hanger Fastener

PRODUCT

Cable Duct Type C



Cross Cable Duct C



Elbow Cable Duct C



IR Cable Duct C



OR Cable Duct C



Reducer Cable Duct C



Tee Cable Duct C



Joining Cable Duct C

PRODUCT

Cable Duct Type U

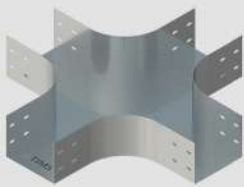

Cross Cable Duct U

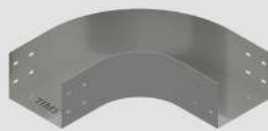

Elbow Cable Duct U



IR Cable Duct U



OR Cable Duct U



Reducer Cable Duct U



Tee Cable Duct U



Joining Cable Duct U

PRODUCT

Ladder H



Cross Ladder H



Elbow Ladder H



IR Ladder H



OR Ladder H



Reducer Ladder H



Tee Ladder H



Joining Ladder H

PRODUCT

Ladder U



Cross Ladder U



Elbow Ladder U



IR Ladder U



OR Ladder U



Reducer Ladder U



Tee Ladder U



Joining Ladder U

PRODUCT

Ladder W



Cross Ladder W



Elbow Ladder W



IR Ladder W



OR Ladder W



Reducer Ladder W

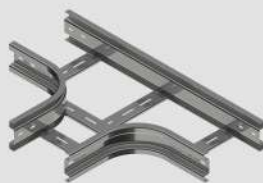

Tee Ladder W



Jointing Ladder W

PRODUCT

Tray C

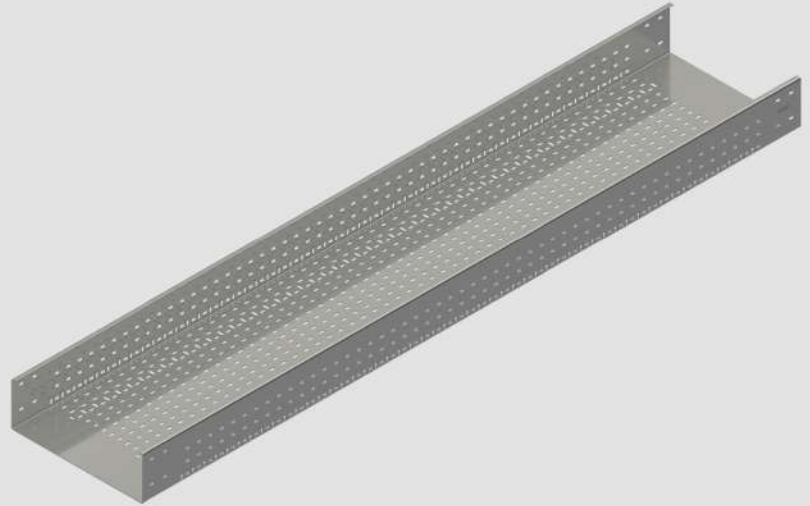

Cross Tray C



Elbow Tray C



IR Tray C



OR Tray C



Reducer Tray C



Tee Tray C



Jointing Tray C

PRODUCT

Tray U

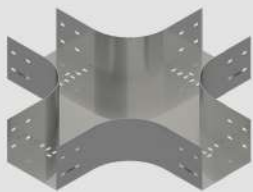
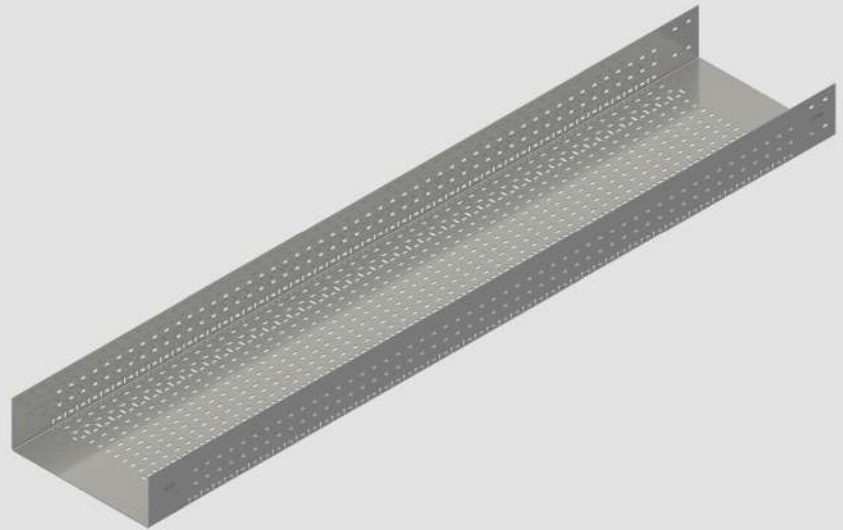

Cross Tray U

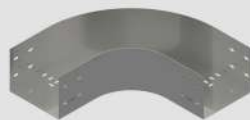

Elbow Tray U



IR Tray U



OR Tray U



Reducer Tray U



Tee Tray U



Jointing Tray U

PRODUCT

Accessories

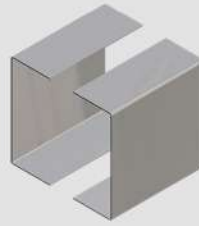

Cover Clip



Cover



End Plate



Hanger Beam



Bolt & Nut



Bracket Mounting

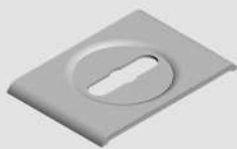

Clamp U40



Cover Clamp



Dinabolt



Dinaset



Elbow Bracket



Hanger Rod



Hold Down Clamp



Ring

SPEKIFIKASI

CAGE CABLE

Base Material	:	Drawn Wire & Stainless Steel SS 304
Thick base material	:	W50 Up to W400 ϕ Wire 5mm W500 Up to W600 ϕ Wire 6mm
Material length	:	3000mm, accessories length diverse

TRAY & LADDER

Base Material	:	Black Plat (Hot rolled coil plate/ SPHC) Stainless Steel & Aluminium
Thick base material	:	1.8 mm, 2 mm & custom
Material length	:	3000 mm, accessories length diverse

FINISHING

- Standard finishing for tray, ladder & cage are ;
Elektro Plating

Girth	:	Minimum 11 microns
Color	:	Silver dop/ dull grey

- Standing finishing for tray, ladder & cage are ;
Hot Dip Galvanize

Girth	:	Minimum 65 microns
Color	:	Silver dop/ dull grey
Standard Hot dip	:	ISO 9001 : 2015/IAS/QMS/C1485

- Finishing Powder Coating can be ordered specifically.

Type of Goods	Min Width. (mm)	Max Width. (mm)	Height (mm)
Cable cage	50	600	100 & 50
Cable duct type C	50	900	100 & 50
Cable duct type U	50	1000	100 & 50
Ladder type H	100	1200	100 & 50
Ladder type U	100	1200	100 & 50
Ladder type W	100	1200	100
Tray type C	50	900	100 & 50
Tray type U	50	1000	100 & 50

PRODUCT TIMS

Product TIMS (Cage, Ladder & Perforated) is a product produced by PT Titian Makmur Sentosa that offers benefits or advantages in the appeal of other products (traditional).

TIMS came to be a part in the development in Indonesia to produce a product that can provide solutions for the electrical wiring and telecommunications.

TIMS has always been committed to continue to provide a good quality of the product which is already being tested and proven products have a place in the field of TIMS industry cable tray especially among contractor in the field of mechanical and electrical. TIMS has been certified by SUCOFINDO.

ADVANTAGES

- Could be installed quickly and being assembled to easily.
- Are strong and lightweight, this is because product derived from high quality raw materials and pass the appropriate standard finishing process.
- Fireproof.
- Won't broke easily.
- Products TIMS (Cage, Ladder, Perforated) provide a modern air circulation system which will always keep the wired network in a cold circumstans and it makes the cable easy to maintenance.

SERVICE

TIMS is committed to continue to provide good service to consumers by providing quality products at competitive prices and backed by prompt and proper delivery (on schedule).

CAGE CABLE DISTANCE

TIMS Cage Dimention

Standard length 3000mm
Hot dip Galvanized, Elektro Plating and Powder Coating

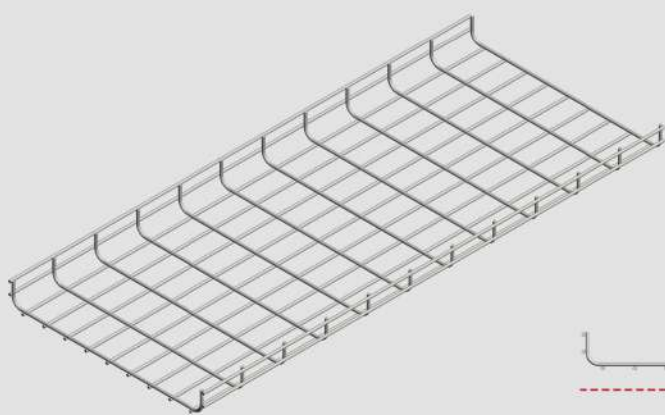

Distance A in mm

50
100
150
200
300
400
500
600

TIMS Cage Dimention

Standard length 3000mm
Hot dip Galvanized, Elektro Plating and Powder Coating

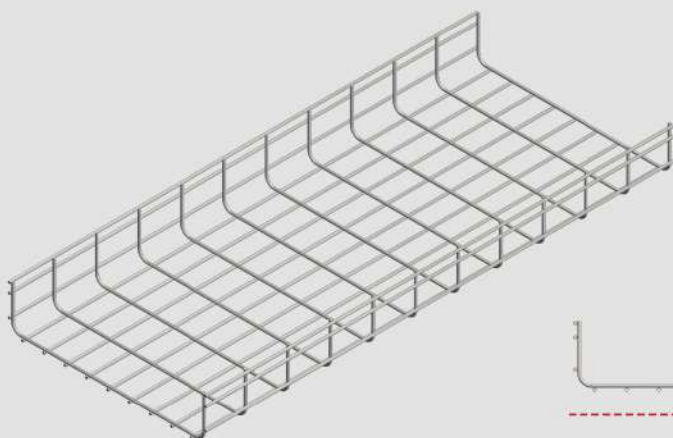

Distance A in mm

100
150
200
300
400
500
600

INSTALLATION POWER

Cage

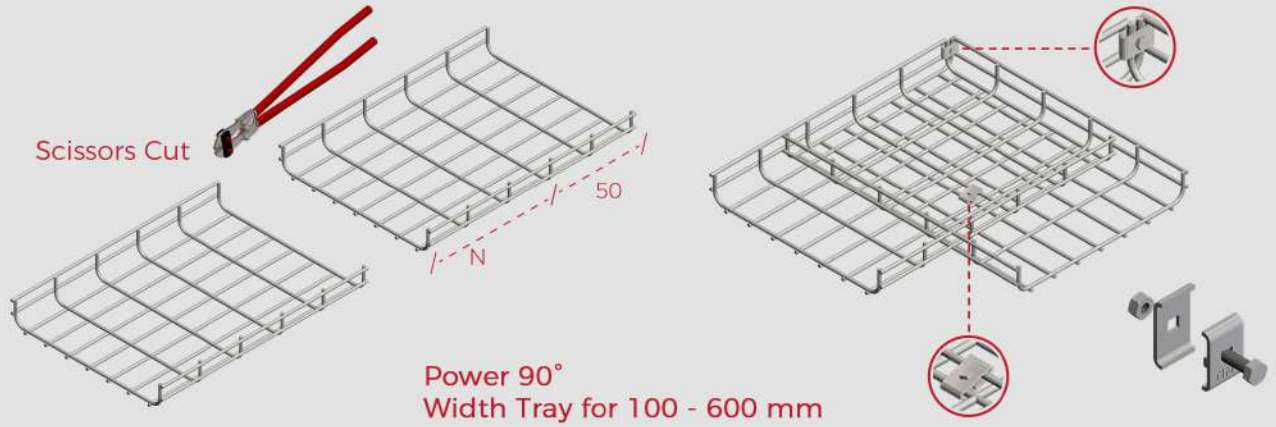

A	100	159	200	300	400	500	600
B	300	400	400	500	600	700	800
N	100	200	200	300	400	500	600

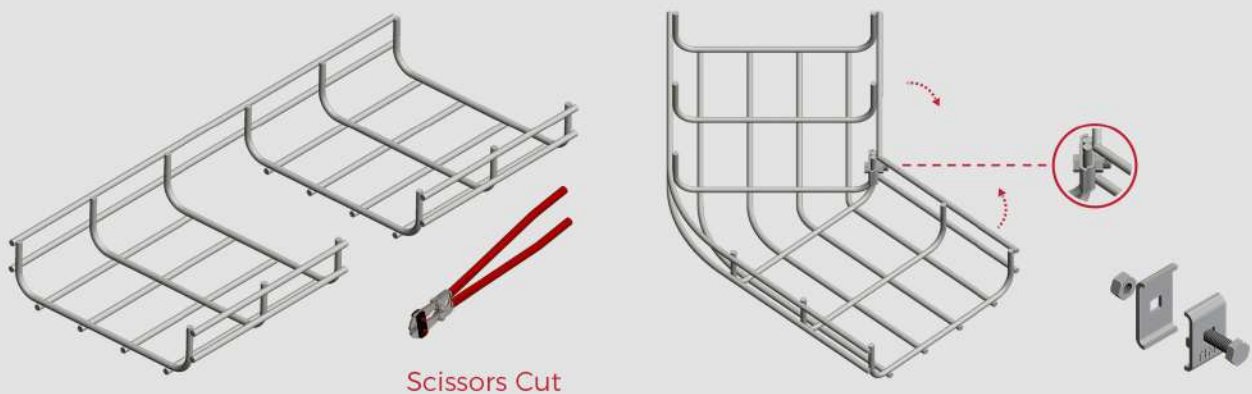

TIMS CATALOGUE

INSTALLATION POWER

WIDTH TRAY FOR
100 - 150 mm

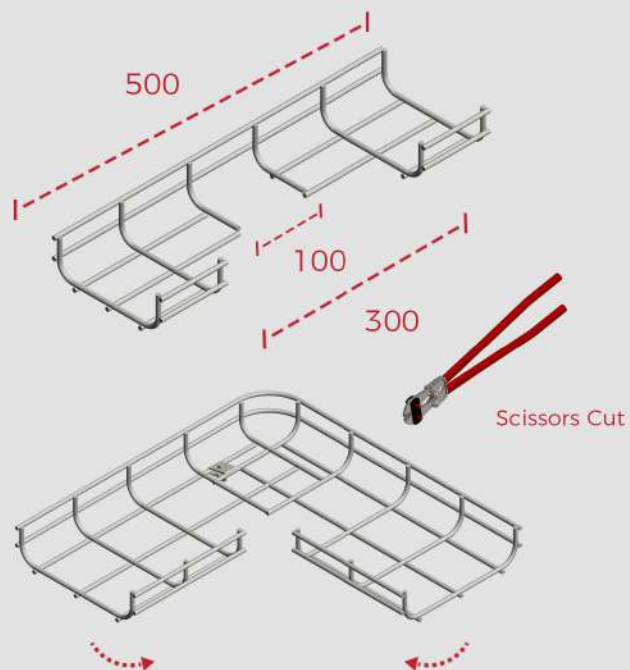
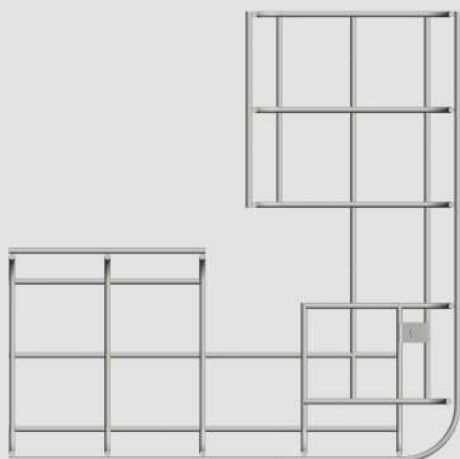

WIDTH TRAY FOR
200 - 600 mm

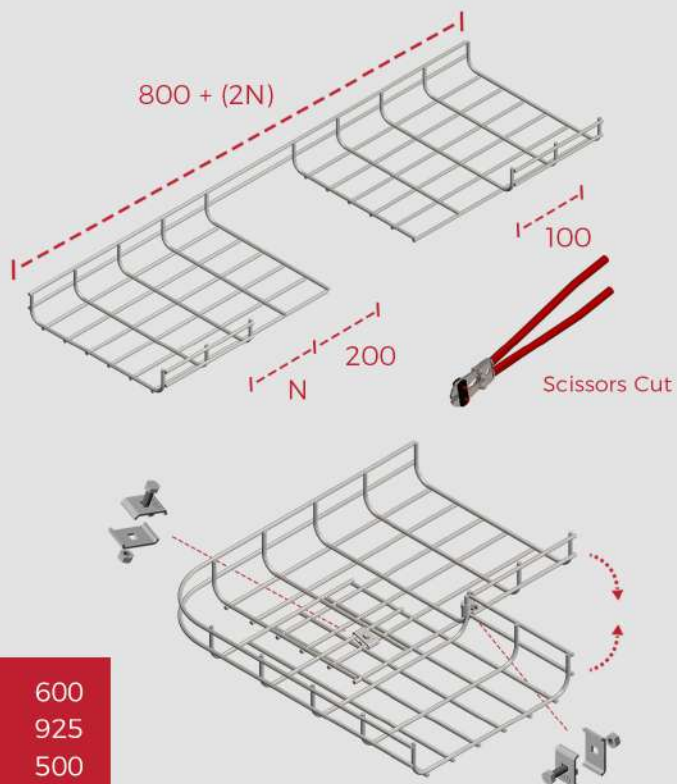
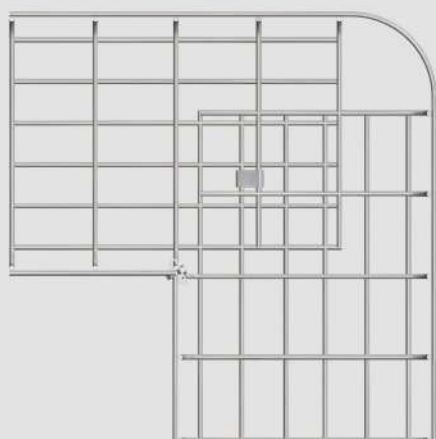

A	200	300	400	500	600
B	525	625	725	825	925
N	100	200	300	400	500

INSTALLATION POWER

WIDTH TRAY FOR
300 - 600 mm

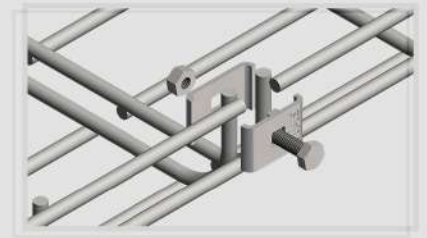
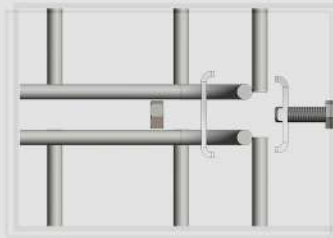
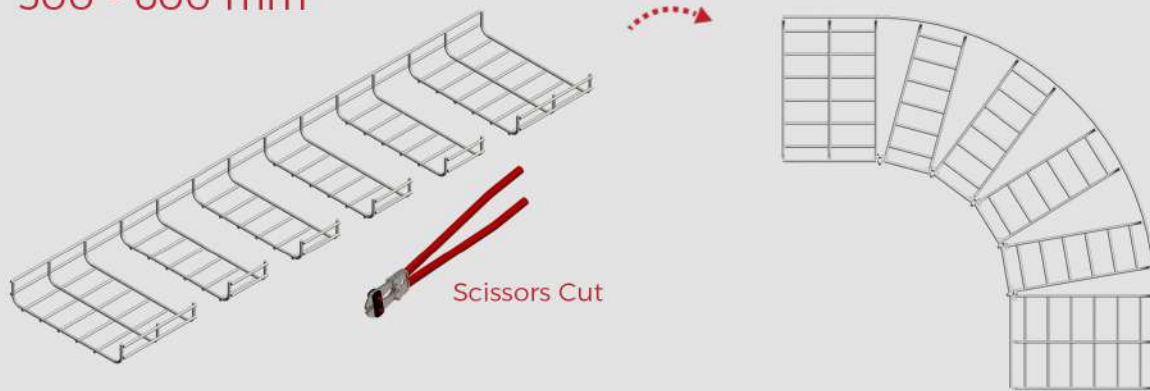

A	300	400	500	600
B	570	840	920	1300
L	1300	1700	2100	2300
X	5	7	9	10

HORIZONTAL SHIF
300 - 600 mm



TIMS CATALOGUE

INSTALLATION POWER

EXAMPLE of ASSEMBLY

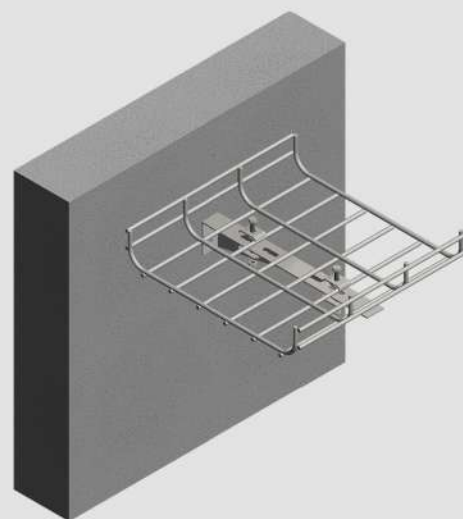
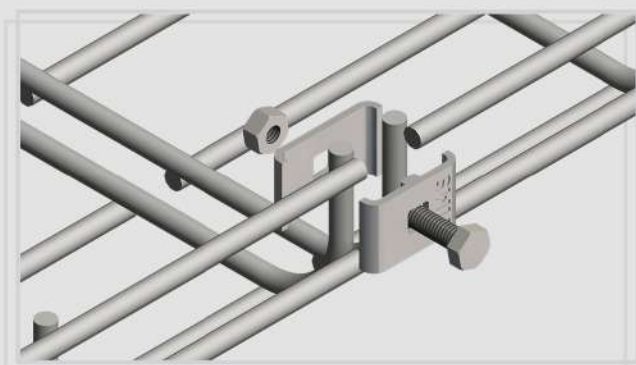
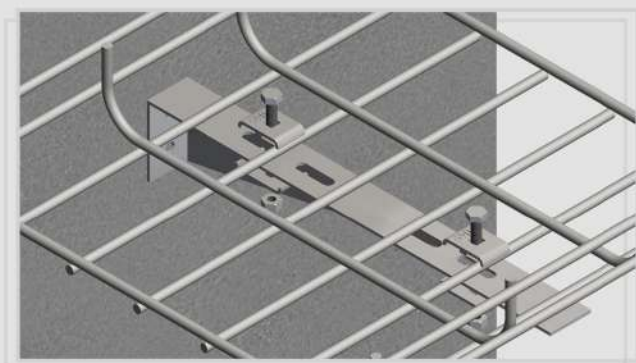

INSTALLATION

REDUCER

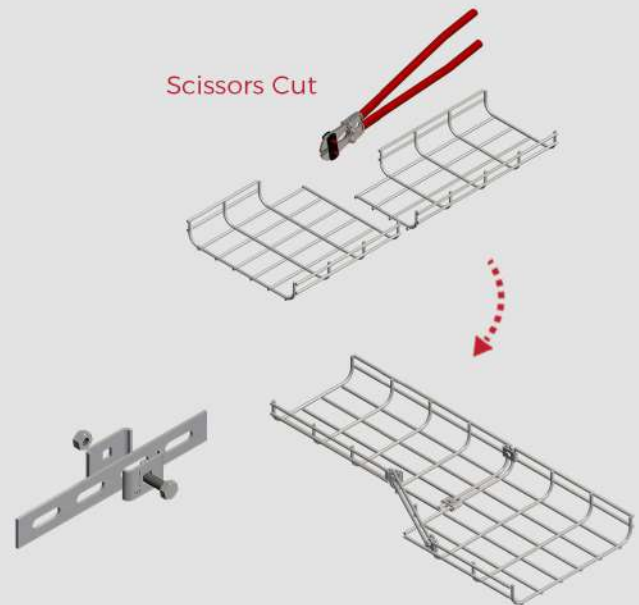
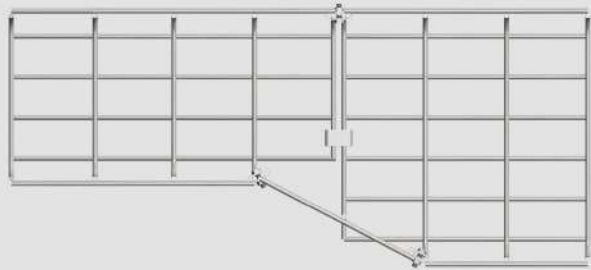

CONNECTIONS TEE

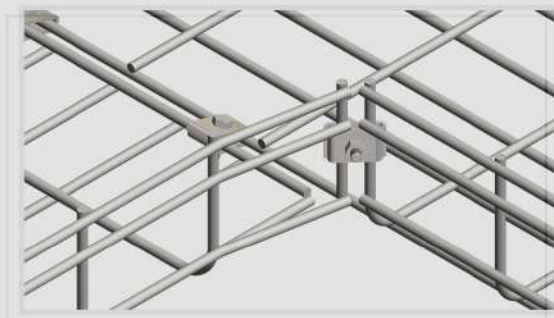
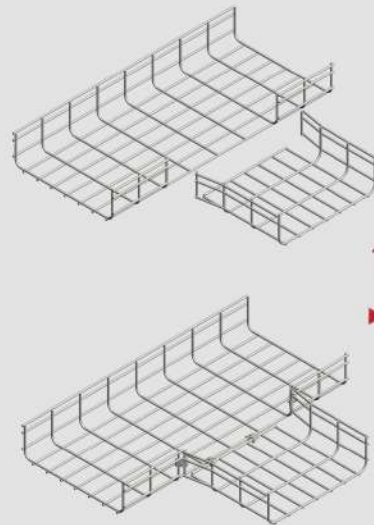
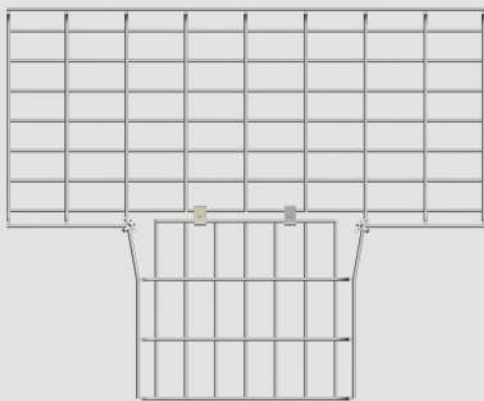

CONNECTIONS TEE
Joiner U20 U30 c/w Bolt Nut

PRODUCT

HOW TO CUT

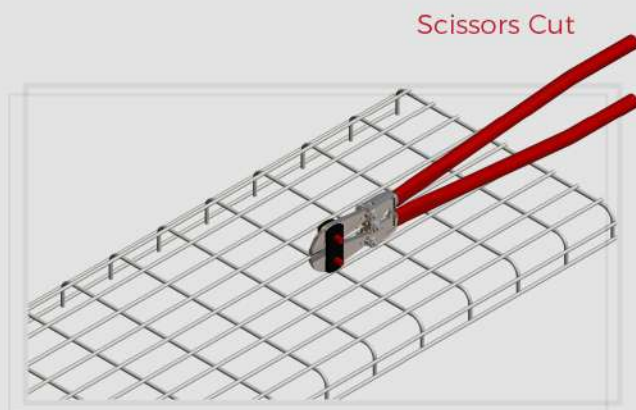
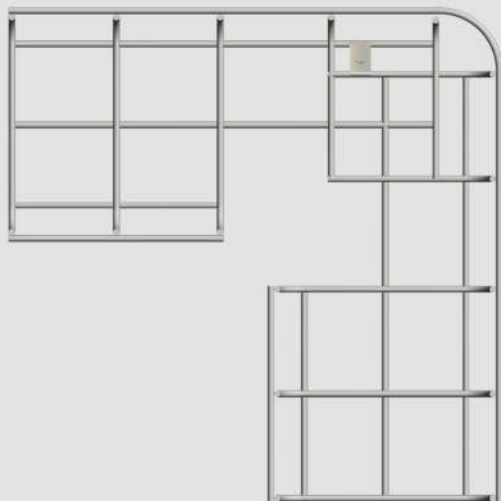

CUT THE MEASUREMENT CONNECTION

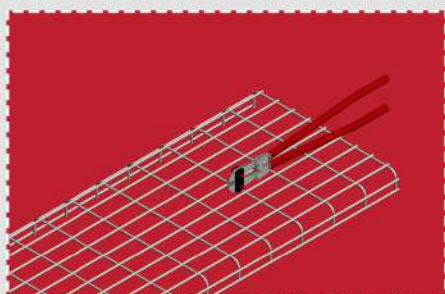
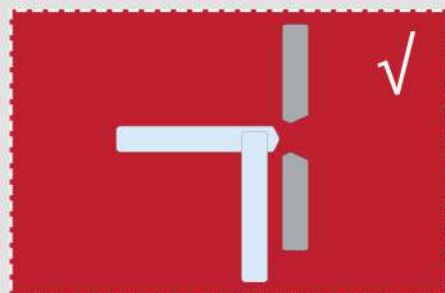
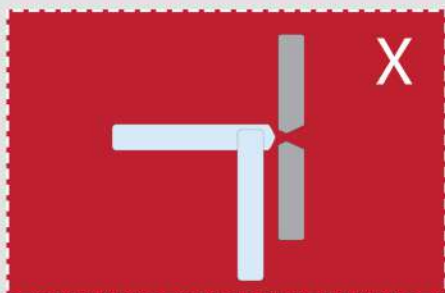

Position Cut



Side Position Cut

CATALOGUE

TIMS

Jln Menjangan Raya No 68
Kelurahan Pondok Ranji,
Kecamatan Ciputat Timur
Tangerang Selatan

Tel. 021 2931 8225 /
021 2931 8226 /
021 2931 8227

Fax. 021 7424 881 /
021 290 432 15

Email titianmakmursentosa@yahoo.com
marketing@titianmakmursentosa.com